

LISA Patch Cassette

Description

LISA patch cassette, 12 x MTP adaptor, black
 PT3-H-MTPS-12-ZZ-O

Features

- LISA patch cassette for cross-connect configuration
- Up to 12x MTP connectivity per cassette
- Tool less installation and clear labelling for quick identification/ traceability
- Cassette access from the front and side facing adapter alignment for higher laser safety
- Patch cords horizontally supported and full 30 mm bend-radius limitation throughout

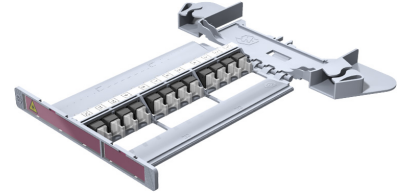

Technical data

Mechanical data

Characteristics	Values
Product family	LISA
Suitable for	Patching
Dimension (Width x Length x Height) (mm)	259 x 241 x 19
Dimension (Width x Length x Height) (inch)	10.2 x 9.5 x 0.7
Weight (g)	294
Weight (oz)	10.4
Number of Adaptor front (pcs)	12
Adaptor type front	MTP12
Adaptor colour front	black

Environmental data

Characteristics	Values
Temperature resistance (min to max) (°C)	-40 to 70
Temperature resistance (min to max) (°F)	-40 to 158
UL Rating	UL 94 V-0
Chemical resistance	Yes
UV resistance	Yes
Resistance to impact	IK03
Free of halogen	Yes
RoHS compliant	Yes
REACH compliant	Yes

LISA Patch Cassette

Technical drawing

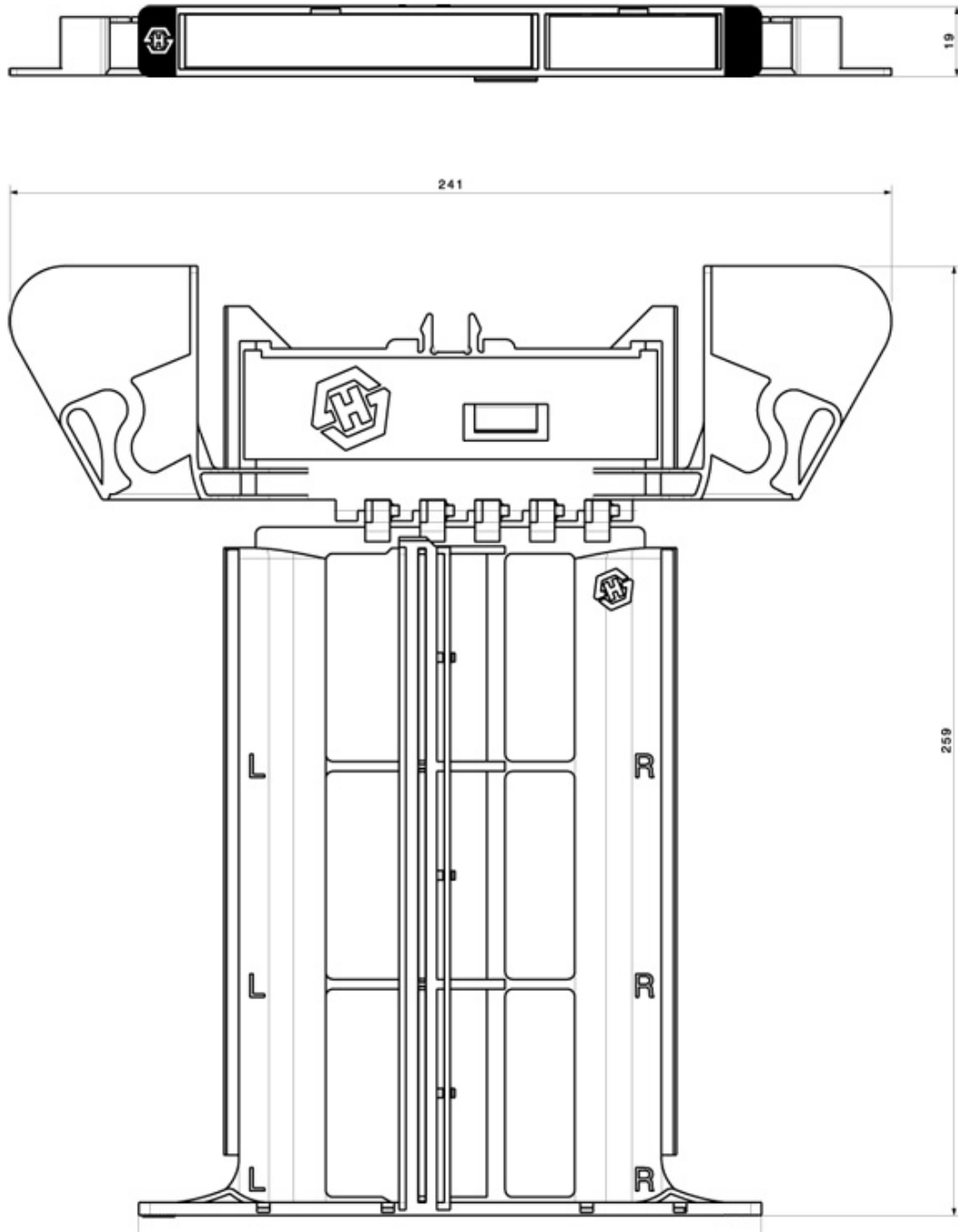

Ordering information

Description	Item number
LISA patch cassette, 12 x MTP adaptor, black	85103005

Related Documents

Installation manual	DOC-0000783226
---------------------	----------------