

Product updated on October 17, 2018

Ultra High Density MPO/MTP™ Adaptor Module

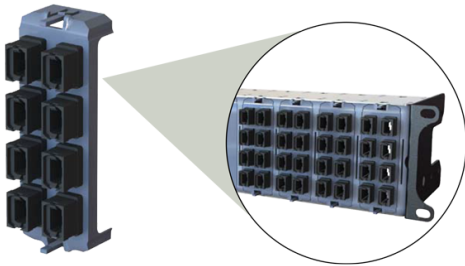

MPO/MTP adapter modules are used to interconnect MPO/MTP trunks, pigtails, patchcords or ruggedised MPO/MTP fanouts. MPO/MTP adapter interface reduces rack space usage. Substituting MPO/MTP module with adapter plate reduces amount of interconnections and improves power budget and network economics.

FEATURES/BENEFITS

- MPO/MTP adapter plates
- Up to 12 MPO/MTP adapters per plate
- Key-Up Key-Down adapters option (Standard ploarity A/C)
- Key-Up Key-Up adapters option (Polarity B)
- 5 adapter plates in 1U, 12 adapter plates in 2U

APPLICATIONS

- Data center
- Storage area network
- Director switch cabling solution

TECHNICAL DRAWING

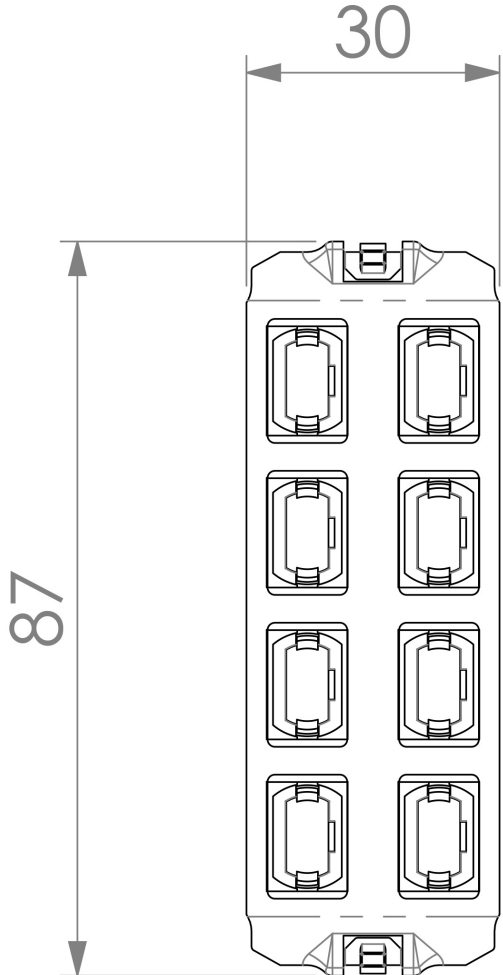
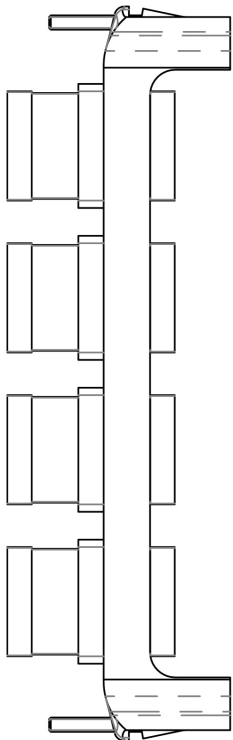
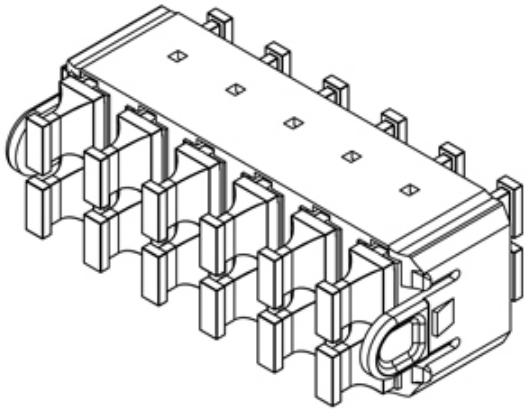
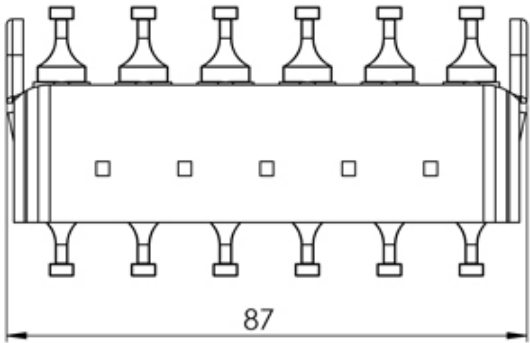
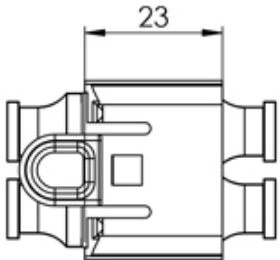
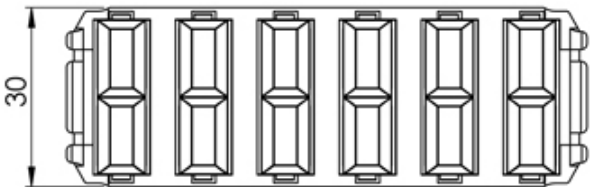

ORDERING INFORMATION

	ADAPTOR COUNT	ADAPTOR TYPE	
UHD	08	A	Key-Up Key-Down
	12	B	Key-Up Key-Up

Example Part Number

UHD	08	A
-----	----	---

This part number generator has created an: Ultra High Density Adapter Plate with 8 Key-Up Key-Down MPO Adapters



FURTHER INFORMATION

- For additional information please contact your sales representative
- To view the product 360 visit the product page (Scan the QR code or visit the link below)
- Downloaded from <https://www.aflhyperscale.com/product/uhd-mpo-mtp-adaptor-module>
- AFL Hyperscale reserves the right to make changes in this datasheet at any time without notice
- Information in this document is correct as of October 17, 2018

SCAN QR FOR PRODUCT PAGE

Europe

+44 (0) 1908 441 144
emeasales@aflhyperscale.com
© AFL Hyperscale 2018

Americas

+1 800 790 9932
usasales@aflhyperscale.com

Middle East & Africa

+971 4 404 9606
mesales@aflhyperscale.com

India

+91 80 46874687
indiasales@aflhyperscale.com

Asia Pacific

+86 755 2561 3694
apacsales@aflhyperscale.com